

MEGATRONICS v3.0 DATASHEET

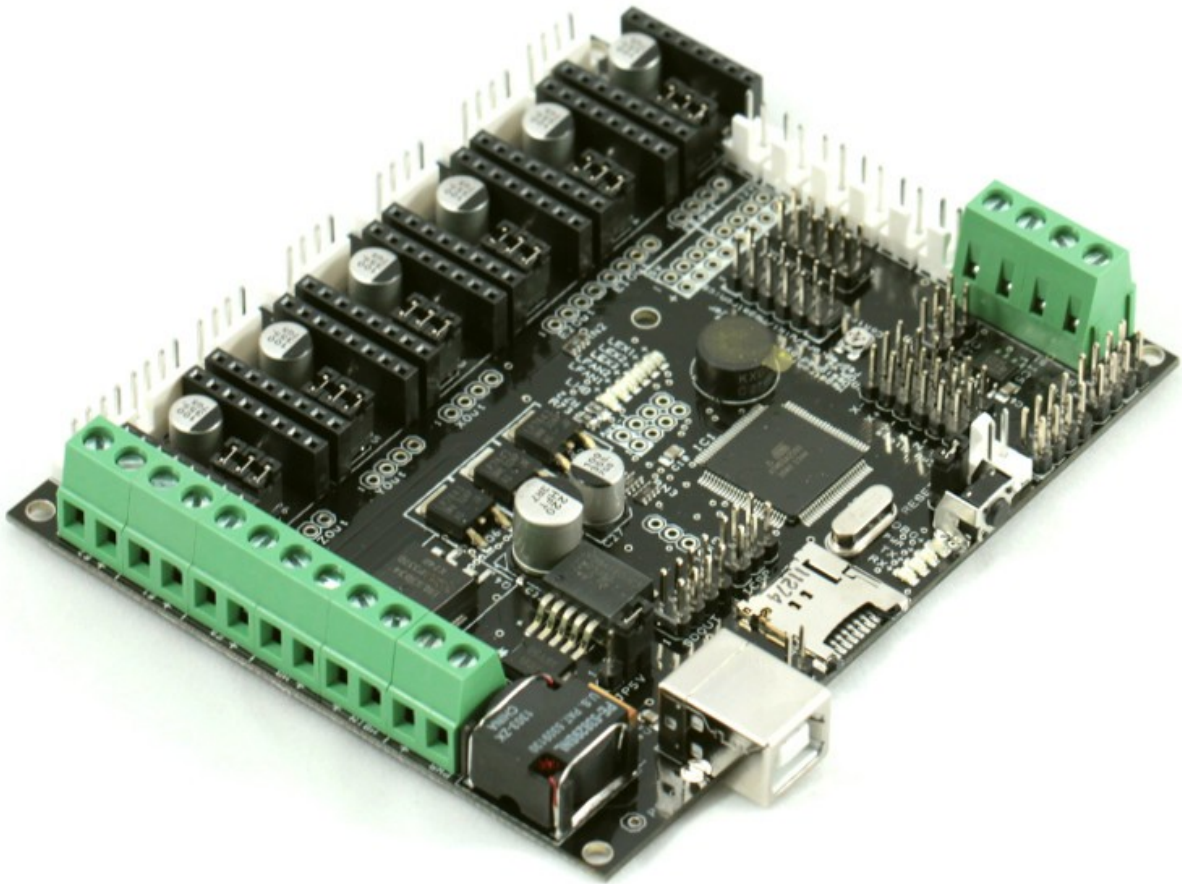

Author Bart Meijer
Date 18th of January 2014
Document version 1.0



ReprapWorld.com

PRODUCT OVERVIEW

Megatronics is based on many famous open-source products including: Arduino Mega, RAMPS, SD Ramps. Therefore this product is an already proven design. It combines all major features of these boards into a single board solution for more reliable 3D-printing.

Megatronics has a powerful Atmega2560 processor with 256 kB memory, running at 16MHz. The board can be connected to a PC using a normal USB cable. It will register as FTDI FT232R device. The board is compatible with the Arduino Mega 2560 and will therefore be easily programmed from the Arduino IDE.

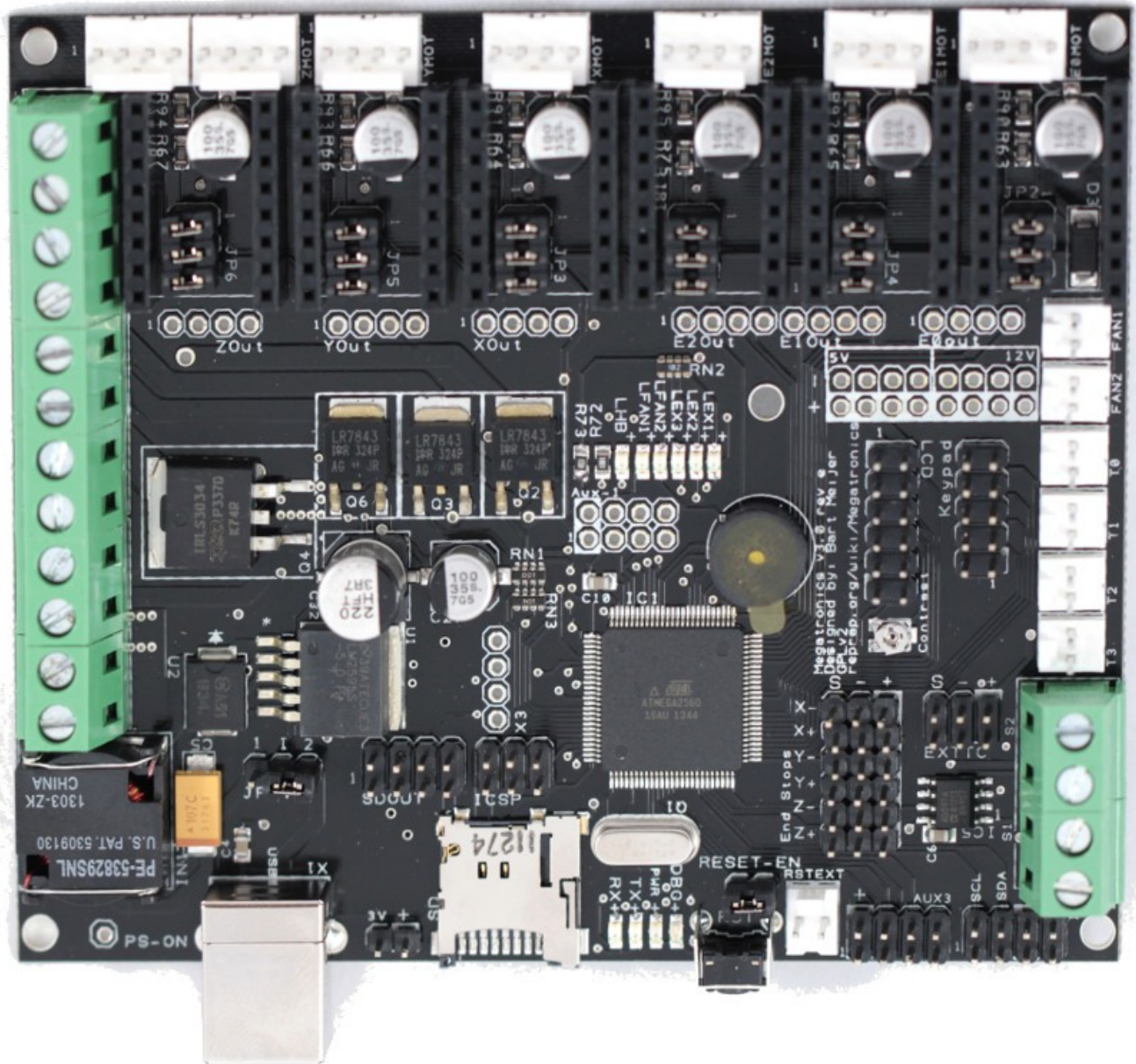

PRODUCT CHANGE HISTORY

Version 3.0

- Added a fourth thermistor header
- Changed motor and thermistor headers to lock headers
- Added support for the external SD card pcb
- Stand-alone printing also possible when powered from 24V
- External reset header added
- External thermo couple board support (2x)
- Support for 3 extruders, 2 fans and a heated bed on board.
- Added more protective features

Version 2.0

- Improved thermo couple support.
- Second thermo couple supported
- Support for 6 stepper drivers
- SMD fuses and MOSFETs
- Extra MOSFET, making 4 regular MOSFETs and one for heated bed.
- Support for the new DRV8825 Pololu stepper drivers

TECHNICAL SPECIFICATION

Microcontroller	Atmega2560-16AU
Operating Voltage Electronics	5V
Operating Voltage High	12-24V (15A heated bed, 7A electronics)
DC Current per I/O Pin	40mA
Clock Speed	16Mhz

MAJOR FEATURES

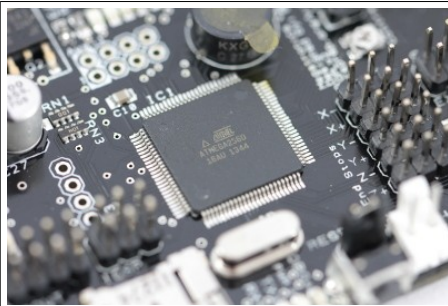

Atmega2560

Powerful Atmega2560 processor with 256 kB memory, running at 16Mhz

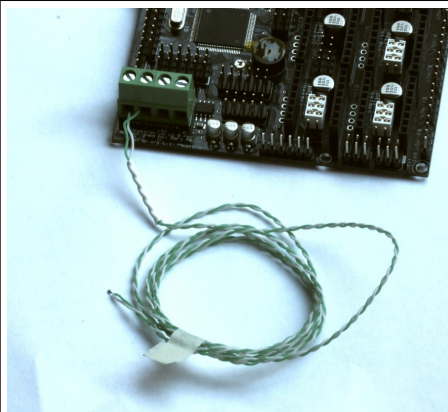

Thermocouple

On board support for connecting two thermo couples two external



SD Card

Autonomous printing from Micro SD card on board or external SD card, using the external SD card PCB module.

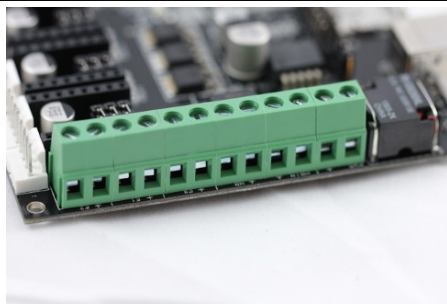

Six MOSFETs

The board has 3 regular MOSFETs (25A), two 1A MOSFETs (fans) and one MOSFET for the heated bed (IRLS3034PBF) to support many needs.

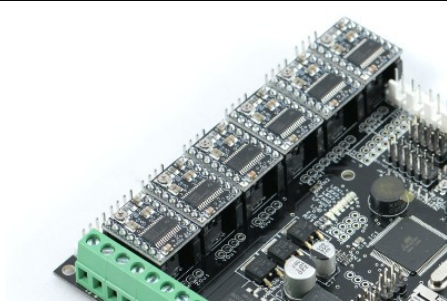

Up to 6 stepper drivers

Compatible with RAMPS, 6 slots for stepper drivers (not included). Modularized to make replacement easy for damaged drivers. Also the new DRV8825 Pololu stepper drivers are supported.

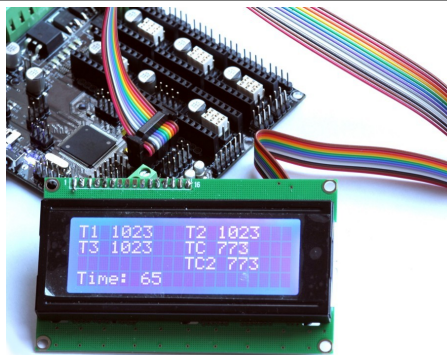

Support for many peripherals

The board's functions can be easily extended with LCD, keypad etc. See the connectors section for more information

OTHER FEATURES

- Auto reset can be disabled by removing a jumper
- The board's low voltage circuit can be powered from 12-24V, by setting a jumper
- The LCD contrast can be adjusted with a trimpot
- PWR has a diode to protect against reverse polarization
- The 5V line is protected by a 500mA resettable fuse
- A piezo is included to allow the printer to give feedback with sound
- Each stepper driver slot has a breakout to connect external stepper drivers to the board.
- Four layer high quality PCB board

CONNECTORS

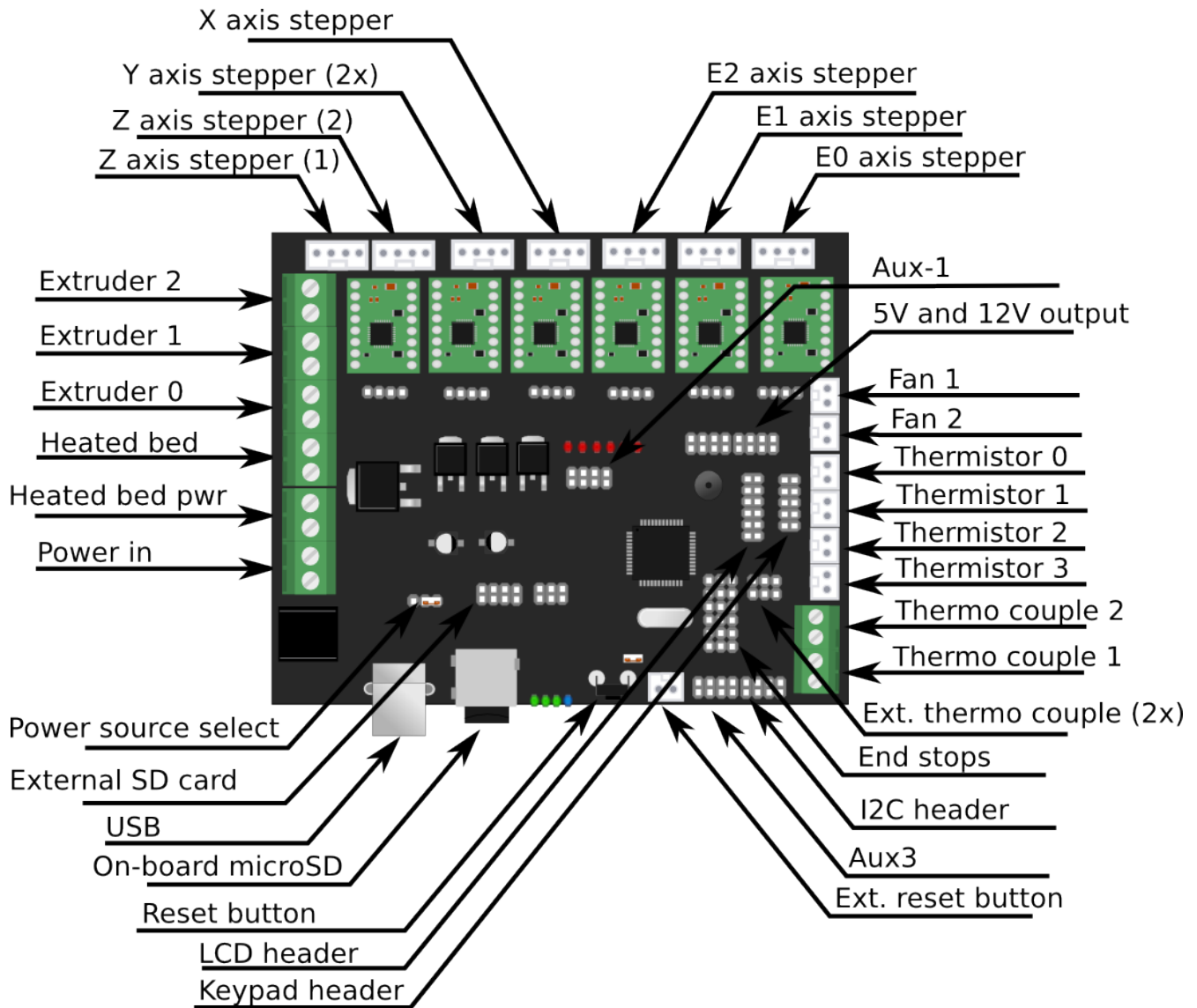

Name	Description
XMOT, YMOT, ZMOT (2x), E0MOT, E1MOT, E2MOT	Connectors for bipolar stepper drivers
JP2-JP7	Microstepping mode jumpers. See your stepper driver documentation for more information.
E0Out - Zout	Breakout headers for stepper slots 1. GND

	<ul style="list-style-type: none"> 2. DIR 3. STEP 4. ENABLE
5V	5V output
12V	12V output
FAN1	Fan 1 (1A max)
FAN2	Fan 2 (1A max)
T0	Thermistor 0
T1	Thermistor 1
T2	Thermistor 2
T3	Thermistor 3
S1	Thermo couple 1
S2	Thermo couple 2
Keypad	Keypad (2x5 header) <ul style="list-style-type: none"> 1. 5V 2. GND 3. D45 4. D33 5. D44 6. D34 7. D43 8. D35 9. D42 10. D36
LCD	LCD Header (2x6 header) <ul style="list-style-type: none"> 1. GND 2. 5V 3. LCD Contrast 4. D32 5. GND 6. D31 7. D14 8. D30 9. D39 10. D15 11. 5V 12. GND
I2C	I2C header (2x4 header) <ul style="list-style-type: none"> 1. SCL 2. SCL

	<ul style="list-style-type: none"> 3. SDA 4. SDA 5. 5V 6. 5V 7. GND 8. GND
AUX3	<p>Auxiliary header 3 (2x4 header)</p> <ul style="list-style-type: none"> 1. 5V 2. 5V 3. D49 4. D48 5. D47 6. D46 7. GND 8. GND
RSTEXT	Header to connect an external reset button.
RESET-EN	When jumpered enables reset (DTR). Without it the board cannot be programmed using the IDE. It's recommended to remove the jumper for production machines.
End stops	6x3 header to connect end stops
SDOUT	<p>External SD card header</p> <ul style="list-style-type: none"> 1. 5V 2. A2 3. MISO 4. MOSI 5. SCK 6. D53 7. GND 8. Not connected
JP5V	<p>Power source select. This determines how the 5V circuit is powered.</p> <ul style="list-style-type: none"> 1: Power from Power In 2: Power from USB
EXTTC	External Thermo couple header
ICSP	2x3 header to program the Atmega chip directly
X3	Breakout for FT232 pins
AUX1	Analog/Serial output (compatible with RAMPS)
PS-On	Header do enable/disable the power supply
E0 - E2	Extruder heater output (5A max)
HB	Heated bed (15A max)

HBIN	Heated bed power (12-24V) *
PWR	Power input (12-24V) *

* Make sure that your peripherals support the input voltage. If you supply 24V, all outputs on the board will supply 24V too.

PIN DEFINITION

This is the digital I/O assignment for Megatronics. You can use it to adjust your firmware to match Megatronics.

Pin	Definition	Pin	Definition
D0	RXD	D38	Y+ End stop
D1	TXD	D39	LCD6
D2	Extruder 0	D40	X+ End stop
D3	Z axis enable	D41	Y- End stop
D4	Y axis enable	D42	Keypad D42
D5	Y axis step	D43	Keypad Shift clock
D6	Fan 2	D44	Keypad encoder (2)
D7	Fan	D45	Keypad encoder (1)
D8	Extruder 2	D46	AUX3-6
D9	Extruder 1	D47	AUX3-5
D10	Heated bed	D48	AUX3-4
D11	Z axis direction	D49	AUX3-3
D12	PS-on	D50	MISO
D13	Debug LED	D51	MOSI
D14	LCD 4	D52	SCK
D15	LCD 7	D53	SS
D16	Z axis step	A0	AUX1
D17	Y axis direction	A1	AUX1
D18	Z- End stop	A2	SDOUT
D19	Z+ End stop	A3	X axis direction
D20	SDA	A4	X axis step
D21	SCL	A5	X axis enable
D22	E2 axis direction	A6	E2 axis step
D23	E2 axis enable	A7	Speaker
D24	E1 axis direction	A8	Thermo couple 4
D25	E1 axis step	A9	Thermo couple 3
D26	E1 axis enable	A10	Thermo couple 2
D27	E0 axis direction	A11	Thermo couple 1

D28	E0 axis step	A12	Thermistor 4
D29	E0 axis enable	A13	Thermistor 3
D30	LCD5	A14	Thermistor 2
D31	LCD Enable	A15	Thermistor 1
D32	LCD RS		
D33	Keypad D33		
D34	Keypad shift out		
D35	Keypad shift LD		
D36	Keypad D36		
D37	X- End stop		

BOARD DIMENSIONS

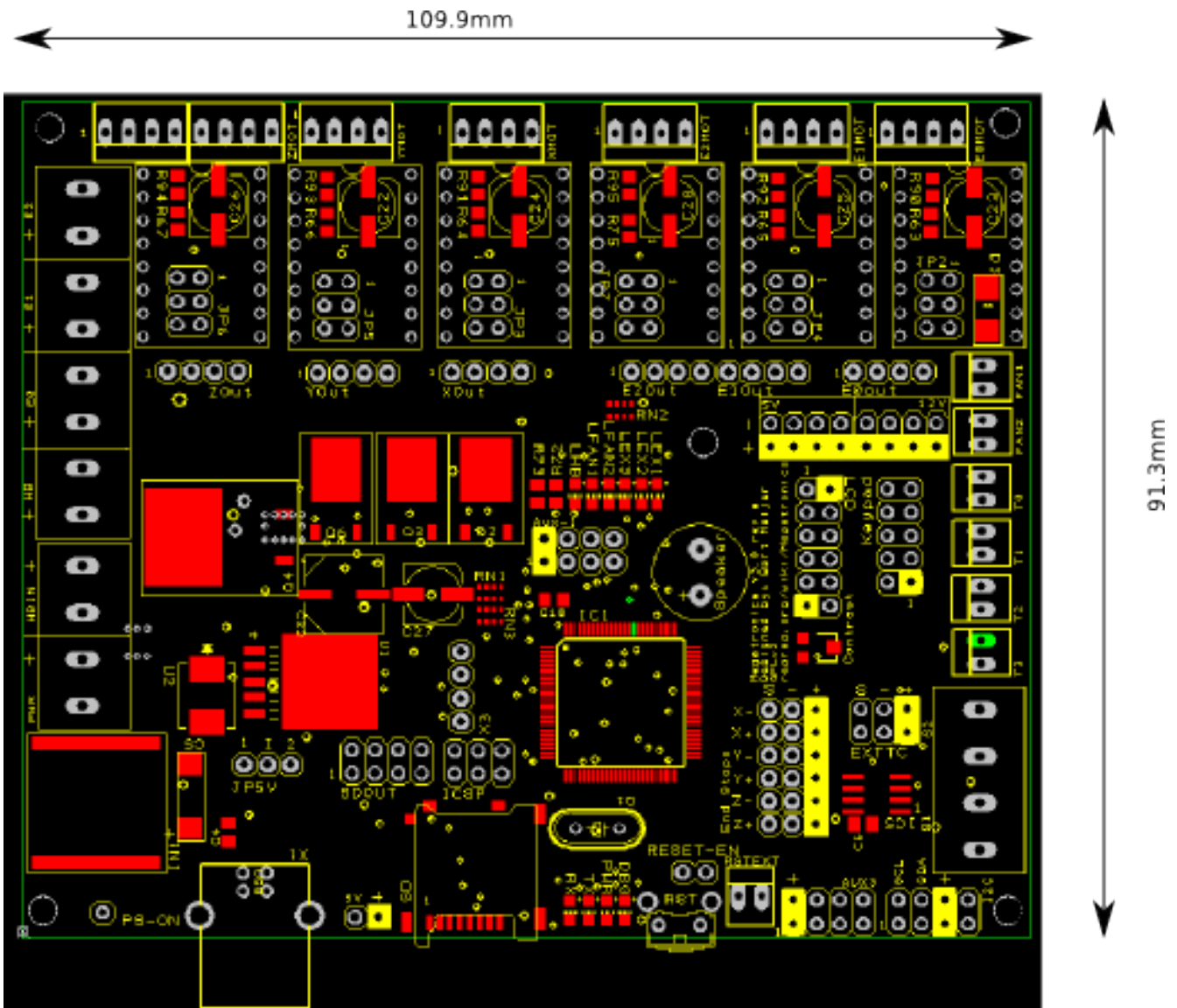

List of M3 holes (measured from the bottom left):

2.3,	3.0
3.0,	88.5
74.3	54.1
107.5	3.0
107.3	89.0